



ORPHEUS ZERO

USER MANUAL



INTRODUCTION

FEATURES

- Class 1 product
- CD drive (ORPHEUS ZERO Drive) or player (ORPHEUS ZERO Player)
- Multiple formats reader : CD, CD-R, CD-RW
- Software controlled mode switching
- Balanced and unbalanced outputs
- Efficient menu driven operation, display and navigation buttons

CONTENTS

- Introduction 2
- Front panel description 3
- Rear panel drive description 4
- Rear panel player description 5
- Top view..... 6
- Connections drive 7
- Connections player 8
- Display and menu structure 9
- Setup and operations..... 10
- Setup and operations..... 11
- Setup and operations..... 12
- Specifications..... 13

UNPACKING

First check and identify the contents of your Orpheus Zero package, as listed below :

- Orpheus Zero compact disc drive or player
- CD manual

If any item should be damaged or missing, please inform your supplier without delay.

Keep the packing material, you may need it to transport the unit in the future.

ADVICE AND WARNINGS

READ THIS BEFORE OPERATING YOUR UNIT

- Please read this manual carefully, to assure proper operation and the best possible performance.
- Switch off the unit before connecting or disconnecting any input or output wire.
- Do not touch the inner pins of rear-panel connectors, electrostatic discharge may cause permanent damage to the unit.
- Choose the installation location for the unit carefully. Avoid placing it in direct sunlight or close to a source of heat. Avoid also locations subject to vibration and excessive dust, heat, cold or moisture.
- To reduce the risk of fire or electric shock, do not expose the unit to rain or moisture.
- Do not use force when operating switches, knobs and other controls.

- Do not open the chassis or attempt to make repairs by yourself, as this may result in damage to the unit or electrical shock. If a foreign object should get into the unit, contact your local dealer for technical support.
- When planning not to use the unit for a long period of time, it is advisable to disconnect the power plug from the wall outlet.
- The power switch does not disconnect the complete unit from the main line.
- When there is a storm disconnect the power plug to prevent lightning damages.
- When moving the unit, be sure to first disconnect the power plug and all wires connected from the unit to other equipment.
- When disconnecting the power plug from the wall outlet, always pull directly on the plug, never pull the cord itself.
- Do not attempt to clean this unit with water or chemical solvents, as this may damage the unit or the finish. Use a clean, dry cloth.
- DANGER : Invisible laser radiation when open and interlock failed or defeated. AVOID DIRECT EXPOSURE TO BEAM.
- CAUTION : Do not open the chassis. There are no user serviceable parts inside the Unit; leave all servicing to your local dealer.
- Keep this manual in a safe place for future reference.

FRONT PANEL

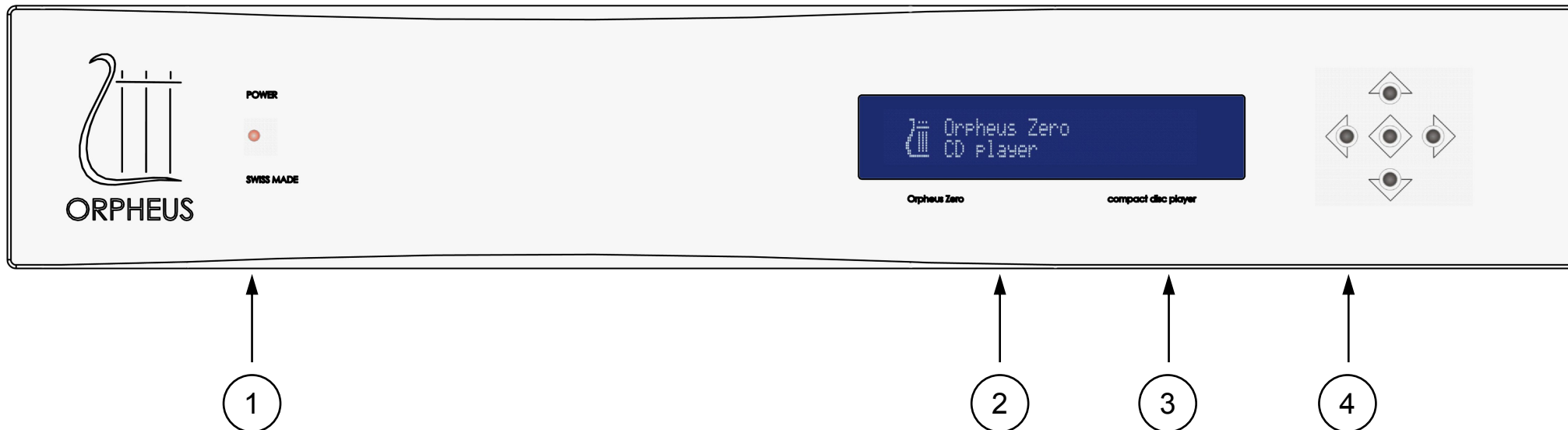

1. MAIN POWER INDICATOR

Light is red when the unit is operating and when it is in standby mode. Indicator light is off when the unit is switched off.

2. DISPLAY WINDOW

Gives all the needed information about CD playing as well as setup menu.

3. INFRARED REMOTE CONTROL SENSOR

Receives signals from the remote control transmitter.

4. CONTROL BUTTONS

Control the playing of your CD and the menu set up.

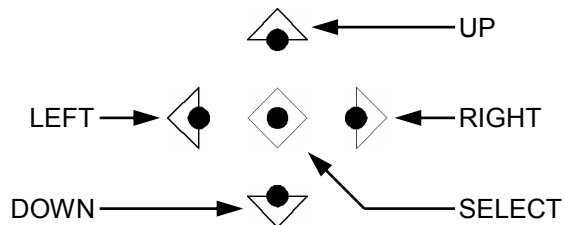

UP

Enables you to play & pause the CD and to go out of the menu set up.

DOWN

Used to stop the CD.

LEFT & RIGHT

Used for choosing tracks, navigating in setup options and choosing values in setup options.

SELECT

Used for entering menu structure and accessing menu options as well as confirming choices and settings.

ORPHEUS ZERO REAR PANEL - DRIVE

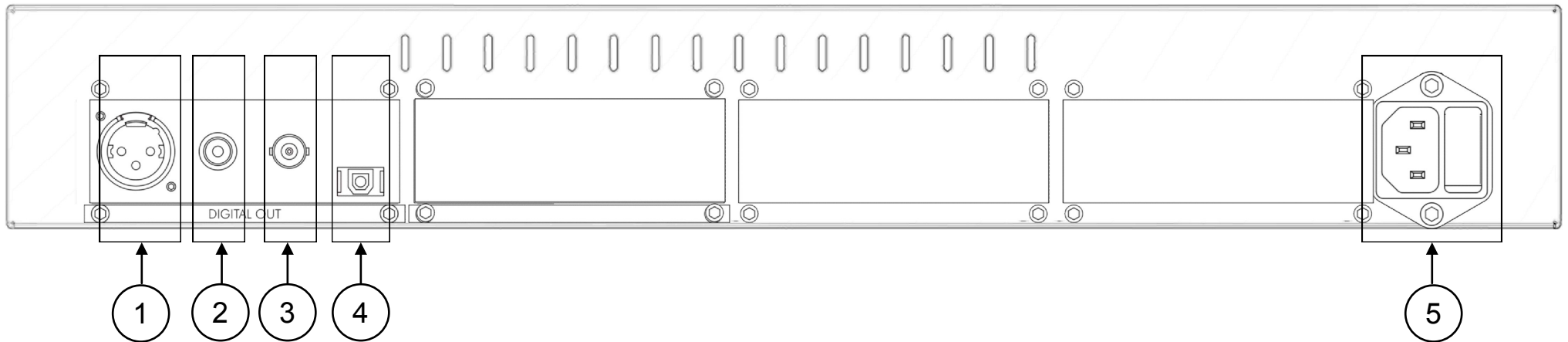

1. OUTPUT AES/EBU FORMAT

Digital data stream output using an XLR connector for AES/EBU format.

2. OUTPUT S/PDIF FORMAT

Digital data stream output using an RCA connectors for S/PDIF format.

3. OUTPUT BNC FORMAT

Digital data stream output using a BNC connectors.

4. OUTPUT TOSLINK FORMAT

Digital data stream output using an optical connector for TOSLINK format.

5. POWER SUPPLY

Power cord connection.

ORPHEUS ZERO REAR PANEL - PLAYER

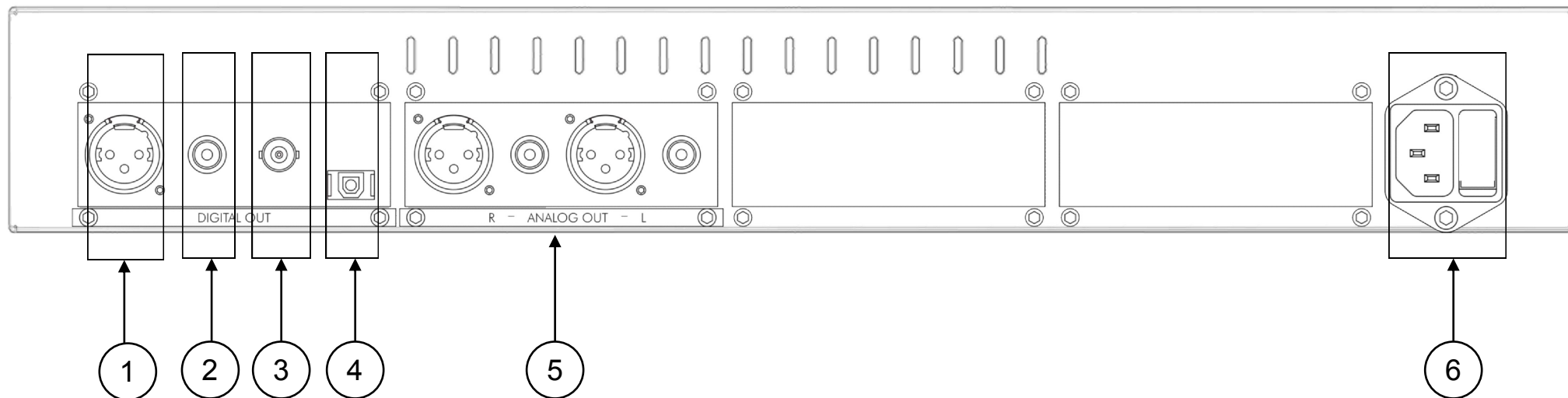

1. OUTPUT AES/EBU FORMAT

Digital data stream output using an XLR connector for AES/EBU format.

2. OUTPUT S/PDIF FORMAT

Digital data stream output using an independent RCA connectors for S/PDIF format.

3. OUTPUT BNC FORMAT

Digital data stream output using a BNC connector.

4. OUTPUT TOSLINK FORMAT

Digital data stream output using an optical connector for TOSLINK format.

5. OUTPUTS

Analogue balanced right and left channel outputs on XLR connectors. Unbalanced right and left channel outputs on RCA connectors.

6. POWER SUPPLY & POWER SWITCH

Power cord connection and main power switch.

ORPHEUS ZERO TOP VIEW

WARNING

Invisible laser radiation when open and interlock failed or defeated. AVOID DIRECT EXPOSURE TO BEAM.

USE

The lit opens and closes manually. Place the CD in the cradle. Close the lit and the unit is in operation. The CD will stop automatically when the lit is opened.

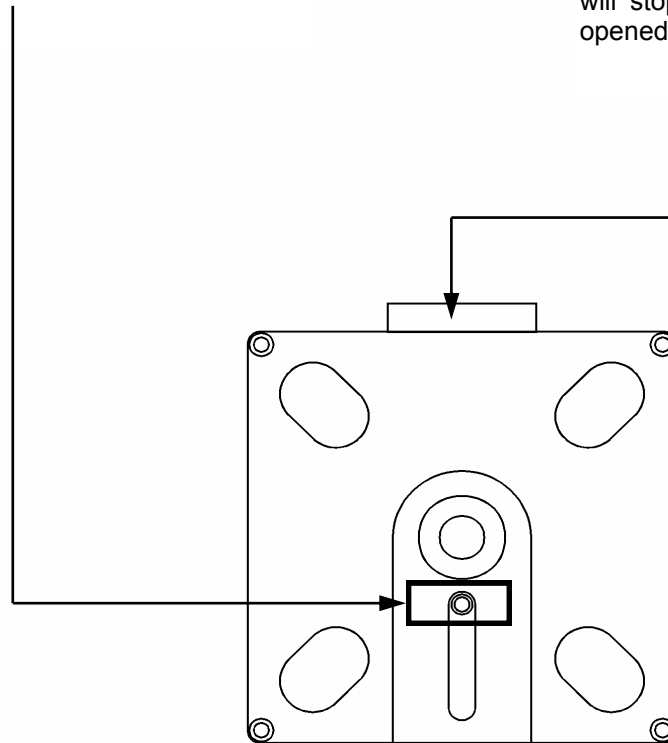

CONNECTIONS - DRIVE

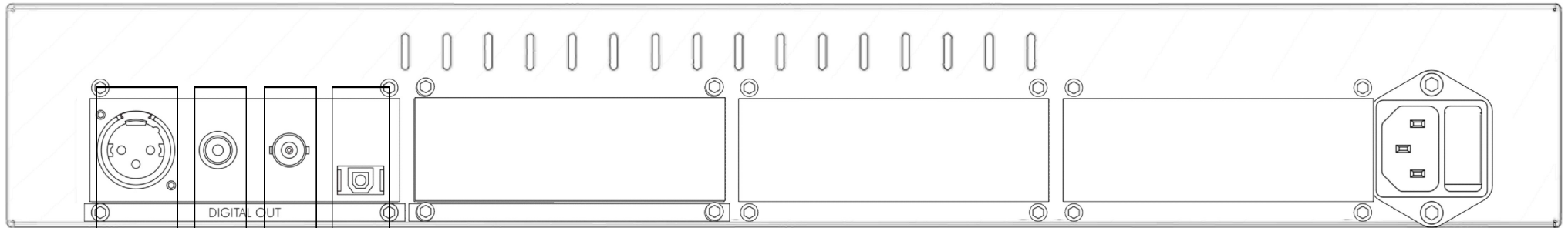

Digital data stream outputs to
D/A converter

RCA OUTPUT CONNECTOR

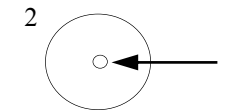

1 : signal in phase

XLR OUTPUT CONNECTOR

Pin 1 : ground

Pin 2 : signal in phase

Pin 3 : signal out of phase

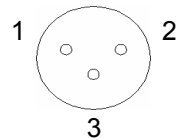

The digital outputs are true floating outputs. Each has its own isolation transformer.

A : AES/EBU
S : S/PDIF
B : BNC
T : TOSLINK

CONNECTIONS - PLAYER

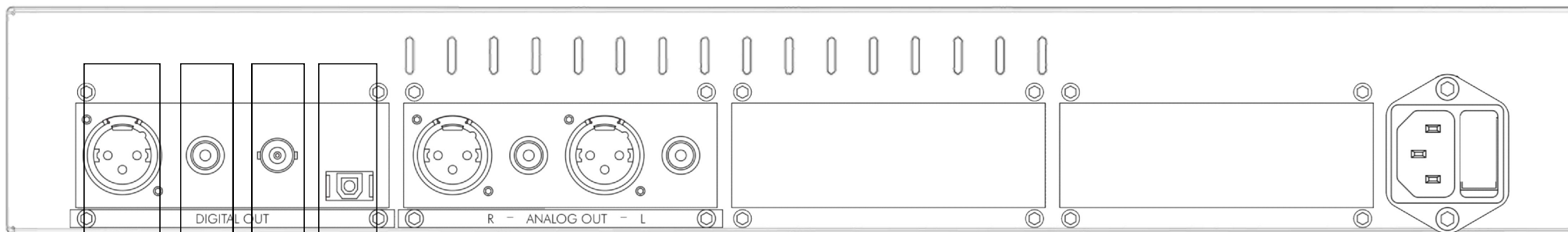

Digital data stream outputs to D/A converter

Analogue outputs, balanced to preamplifier or integrated amplifier.

Analogue outputs, unbalanced to preamplifier or integrated amplifier.

RCA OUTPUT CONNECTOR

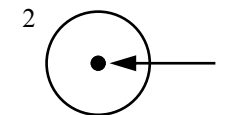

1 : signal in phase
2 : ground

XLR OUTPUT CONNECTOR

Pin 1 : ground
Pin 2 : signal in phase
Pin 3 : signal out of phase

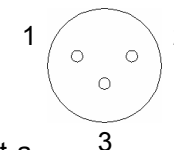

The balanced analog output is not a floating output. Do not connect pin 3 of the connector to ground. If you wish to wire the balanced output to an unbalanced input (with RCA connector), connect pin 1 to ground and pin 2 to signal, and make sure pin 3 is not used.

- A : AES/EBU R : right channel
- S : S/PDIF L : left channel
- B : BNC
- T : TOSLINK

DISPLAY AND MENU STRUCTURE

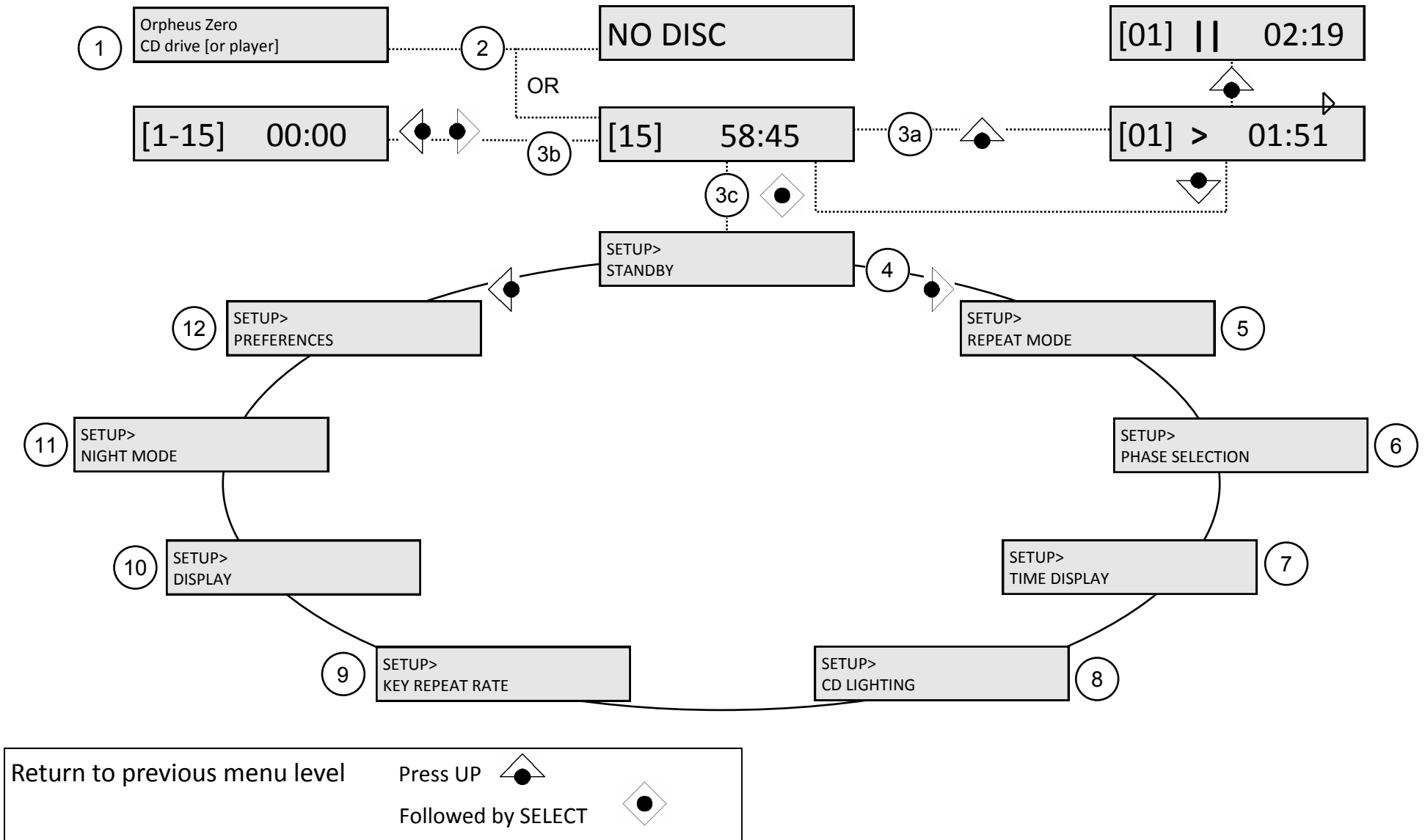

SETUP AND OPERATIONS

QUICK GUIDE

POWER ON

Flip the main power switch on the right hand side of the rear panel from 0 to I.

MAIN SCREEN

After switching on the unit the display window shows the start up screen shortly. It then switches to the default screen which allows to play a CD or entering the menu structure.

PLAY/PAUSE OR STOP A CD

Press **^** to play a track. To pause press **^**. To resume playing press **^**. To stop press **v**.

CHOOSING A TRACK / ACCELERATE THE SPEED OF A TRACK

To choose a track press **<** or **>** until the desired track is displayed. Hold down either **<** or **>** to accelerate the speed of the track search forward or backward

GOING INTO STANDBY

Press **◆** twice.

LOST? RELAX...

Let the system return to the main screen automatically. After approximately 10 seconds of control button inactivity the display returns to the previous menu, and finally to the main screen.

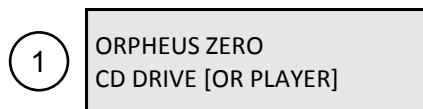

START UP DISPLAY

The start up display is shown approximately 2 seconds when main power is switched on.

It is then replaced by the main screen.

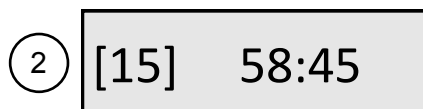

MAIN SCREEN

The main screen is the default display during normal operation.

It indicates the total number of tracks as well as the duration of the CD.

The indication « NO DISC » implies that no disc has been placed in the CD cradle.

Open the lid and place the disc in the CD cradle. Close the lid. The display will indicate « OPEN » and « READING ».

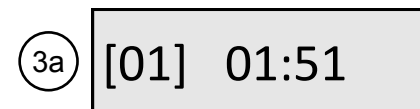

CD PLAYING

To play a track press **^**.

To pause press **^** again.

To resume playing press **^**

To stop the track press **v** or open the lid of the unit. The display returns to default.

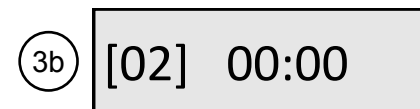

CD PLAYING - CHANGING TRACKS

To play another track press either **<** or **>**. The drive (player) will shift to preceding or following track. This is also optional while playing.

Hold down **<** or **>** to accelerate the speed of the track search forward or backward.

While playing, holding down either **<** or **>** will search forward or backwards to find a specific path of the chosen track.

SETUP AND OPERATIONS

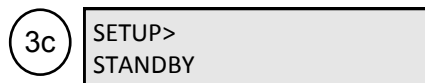

SETUP MENU

From main screen press **◆** to enter setup menu.

To choose between the setup menu options press **<** or **>** until the desired option is displayed.

LEAVING SETUP MENU

At any point in the setup menu you can return to the former menu level by pressing **▲** followed by **◆**.



STANDBY MODE

Pressing **◆** puts the unit in to standby mode.

Pressing any navigation button resumes normal

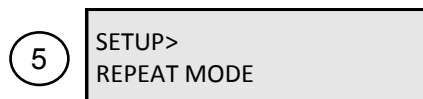

REPEAT A CD OR A TRACK

To enter repeat mode press **◆**

This option enables to repeat with the following options:

- NO REPEAT
- REPEAT TRACK
- REPEAT DISC

To set repeat mode press **<** or **>** until the chosen mode is displayed.

Press **◆** to confirm.

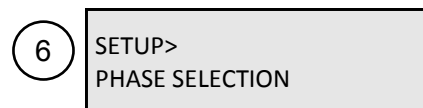

To enter phase selection press **◆**.

This function gives the possibility to select phase. Normal mode gives the natural perspective of the music. Inversion mode changes the absolute phase by 180 dg.

Options:

- NORMAL
- INVERSION

To set phase press **<** or **>** until the chosen phase is displayed. Press **◆** to confirm.



To enter time display mode press **◆**.

The time display gives precise information of timing remaining or time elapsed on the track or on the whole disc.

Options:

- TRACK ELAPSED TIME
- TRACK REMAIN TIME
- DISC ELAPSED TIME
- DISC REMAIN TIME

To select time display press **<** or **>** until the chosen time display mode is displayed.

Press **◆** to confirm.

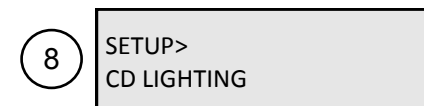

To enter CD lighting mode press **◆**.

This lighting is available as an option only when the CD cradle lid is open. As soon as the lid is closed the lighting is switched off.

Options:

- ON
- OFF

To select CD lighting press **<** or **>** until the chosen option is displayed. Press **◆** to confirm.

SETUP AND OPERATIONS

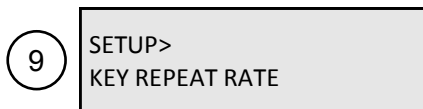

KEY REPEAT RATE

To enter key repeat rate press **◆**.

Holding down < or > is the same as repeatedly pressing them. The repetition rate can be adjusted in three intervals.

Options:

- SLOW (0,6 seconds)
- MEDUIM (0,4 seconds)
- FAST (0,2 seconds)

To set repeat rate pres < or > until the chosen mode is displayed. Press **◆** to confirm.



DISPLAY

To enter display mode press **◆**.

The display lighting can be adjusted from 100% to 20% in 25% steps. The main power indicator light on the left of the front panel is adjusted accordingly.

To increase og decrease the value press **^** or **v**.

Press **◆** to select.

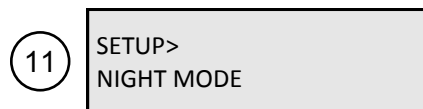

NIGHT MODE

To enter night mode press **◆**.

When night mode i in position ON the display turns off automatically approx. 3 seconds after pressing any button on the remote control.

The unit is still operation and the display lighting is reactivated by pressing any control button.

To set night mode press < or > until the chosen mode is displayed.

Press **◆** to confirm.

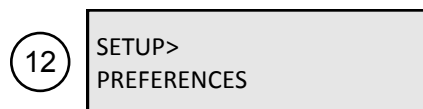

To enter preferences press **◆**.

The various settings allow personalized unit configuration. The personal settings need to be saved before turning off main power.

It is possible to restore previously stored settings as well as to call back the initial factory settings.

Options:

- SAVE
- RESET
- FACTORY SETTINGS

Press < or > until the chosen mode is displayed. Press **◆** to confirm.

In case of RESET and FACTORY SETTINGS press **◆** to confirm again.

FACTORY SETTINGS has following values :

| | |
|-------------------|-----------------------|
| Repeat : | NO REPEAT |
| Phase: | NORMAL |
| Time: | TRACK ELAPSED TIME |
| Cd lighting : | ON |
| Key repeat rate : | MEDIUM |
| Display : | 100% |
| Night mode: | OFF |

SPECIFICATIONS

TECHNICAL DATA

Digital outputs :

S/PDIF, 75 Ohms, 0.5 V P-P, on RCA connector

AES/EBU, 110 Ohm, 2.5 V P-P, on XLR connector.

Measurements: 1kHz sinus sampled at 44.1kHz with 16bits of resolution

Harmonic distortion (THD+N) :

0.0009 % @ -0 dBFS

0.0090 % @ -20 dBFS

0.0900 % @ -40 dBFS

0.9000 % @ -60 dBFS

Dynamic range (THD+N @ -60 dBFS): 100 dBr

Residual noise from 20 Hz to 22 kHz: unmeasurable

TECHNICAL DATA

Optional analog outputs :

Unbalanced, 2V RMS, on RCA connectors

Balanced, 2V RMS, on XLR connectors

Measurements: 1kHz sinus sampled at 44.1kHz with 16bits of resolution

Harmonic distortion (THD+N) :

0.0012 % @ 0dBFS

0.0090 % @ -20dBFS

0.0900 % @ -40dBFS

0.9500 % @ -60dBFS

Dynamic (THD+N @ -60 dBFS) : 100 dBr

Signal to ratio : 115 dBr

Residual noise 20 Hz to 22 kHz : 3,4 µV

Size : 482 x 370 x 44 mm

Weight : 10 kg

Main voltage : selectable

95 - 105 V AC at 50 - 60 kHz

115 - 135 V AC at 50 - 60 kHz

220 - 240 V AC at 50 - 60 kHz

Standby Power : 4 W

Power with the lit closed : 6 W

Power with the lit opened : 7 W

COMMENTS

Constructive feedback is always welcome.

Please feel free to forward us your comments at the address listed below or to your local dealer or distributor.

TECHNOLOGY & DESIGN

The unit has been entirely manufactured and assembled in Switzerland; conceived and designed by ORPHEUS Media Sàrl.

IMPORTANT NOTICE

Orpheus Media Sàrl reserve the right to make changes to their products or discontinue any product or service without notice. Adequate operating safeguards must be used to minimize hazards. Reproduction of user manual information is permissible only if it is without alteration and is accompanied by all relevant conditions, limitations and notices. Source must be clearly identified when reproducing user manual information.

ADDRESS

ORPHEUS Media Sàrl
Av des Sciences 3
1400 Yverdon-les-Bains
Switzerland

+41 24 423 90 88 phone

info@orpheuslab.com
www.orpheuslab.com

© Orpheus Media Sàrl - 2011
September 2011- rev. 1